

## *Research Article*

# **Design Optimization of a Natural Gas Substation with Intensification of the Energy Cycle**

**Arcangelo Pellegrino and Francesco Villecco**

*Department of Mechanical Engineering, Faculty of Engineering, University of Salerno,  
Via Ponte Don Melillo, 84084 Fisciano, Italy*

Correspondence should be addressed to Francesco Villecco, fvillecco@unisa.it

Received 9 March 2010; Accepted 3 September 2010

Academic Editor: Carlo Cattani

Copyright © 2010 A. Pellegrino and F. Villecco. This is an open access article distributed under the Creative Commons Attribution License, which permits unrestricted use, distribution, and reproduction in any medium, provided the original work is properly cited.

Natural gas is currently the natural substitute of petroleum as an energy source, since the foreseen ending up of this latter in the next decades. As a matter of fact, natural gas is easier to handle, less dangerous to be transported, somehow environmentally more friendly. The gas ducts operate with large flow rates over very long distances at high pressures, which are usually lowered in proximity of the final substations by lamination valves which, in fact, dissipate energy. However, a careful management of the pressure reduction may allow an energy recovery while using the gas expansion to operate a turbine. In this case, gas must be preheated to compensate for the energy required by the expansion. A proper control of all the parameters involved becomes crucial to an intelligent use of these resources. In this paper, the possibility of using a pre-heating system has been examined as a way to intensify the energy cycle in an expansion substation of the city gas network. Fuzzy logic has been used to optimize the natural gas expansion in a turbine to produce electrical energy. A fuzzy system has been designed and realized to control the whole process of gas expansion, from the gas pre-heating to the pressure reduction. The system operates over the whole year, accounting for the pressure, temperature, and gas flow rate variations experienced in the gas line. The exit values of the latter and the inlet value of the gas pressure are selected as input variables, being the output variable the temperature of the pre-heating water at the heat exchanger inlet.

## **1. Introduction: The Quest for Energy**

It is a fact that the world has changed in the last 20 years. In the 70s and 80s, industries were somehow coal and nuclear oriented, the greenhouse effect was not scaring the earth, and Chernobyl disaster was far on the horizon. Today, petroleum is claimed to be over, biomasses are then particularly considered, wind-operated generators are more and more installed [1]. In this new scenery, every possibility of saving energy, either improving a process efficiency or reusing the waste, is appreciated.

Natural gas ducts—substations system can be seen as the current largest network of energy microgenerators in the world. It reaches almost every place, is easy to operate, does not need specialized personnel, and it is relatively safe.

Gas is transported by the pressure gradient necessary to accomplish the equation energy. Detailed first principles modelling based upon fundamental mass, momentum, and energy balances is reported by Fawke [2] and Schobeiri [3]. At the substations where the gas is withdrawn, pressure has to be decreased. This is usually done by simply dissipating the pressure energy in a lamination valve. Gas pressure and, consequently, temperature decrease as an effect of the isoenthalpic expansion, according to the Joule-Thomson coefficient value. Sometimes, gas needs to be preheated to compensate for the temperature decrease occurring [4, 5].

Apparently, there is no way to improve the process, nor to recover anything out of it. However, at a more accurate analysis of the energy balance, something can be done. Actually, velocity of the expanded gas increases during lamination, and turbulence phenomena occur. Part of the energy is thus lost in a useless noisy flux. On the other hand, pressures in the ducts range from 70 to 40 bars, down to 20 in the local distribution, whereas 5 bars are typically requested as a final value in a city network. Variability of pressure associates with similar behaviours of gas temperature and flow rate. All of them change either during the day and in the course of the whole year, without any reproducibility.

Note that the gas final pressure has to be kept stable and the final temperature under 5 centigrades not to have formation of methane hydrates, whatever the temperature, pressure, and flow rate of the inlet gas. An intelligent design of the plant expansion process used to drive a turbine and to produce electrical energy could lead to an energy recovery as large as 15% without interfering with the required stability of the exit pressure [6–15].

It is aim of this paper to design the optimal gas expansion process to achieve the objective of transforming a gas substation in an energy generator.

## 2. The Real Case

The gas substation selected for this paper has to respect some crucial requirements to be eligible for a case study.

- (1) The power production has to be at least as large as 50 kW.
- (2) The pre-heater system available has to be large enough to support the pretreatment necessary for the gas turboexpansion.
- (3) The substation itself has to be large enough to allow the installation of a turbine.
- (4) The access points of the National Electricity Board where to send the electrical energy produced have to be near.

Based on data available from the Gas Company, the substation named  $F$  in the list supplied by the Company was selected, serving the east side of the city.

For this substation, the gas flow rate ranges during the day as shown in Figures 1 and 2, for a summer and a winter day, respectively. The data point out that differences of an order of magnitude are experienced during the year. As a matter of fact, the gas flow rate ranges in a year from about 400 to 12000 m<sup>3</sup>h<sup>-1</sup>.

The behaviour of gas temperature is not different, even if on a less dramatic range of variability.

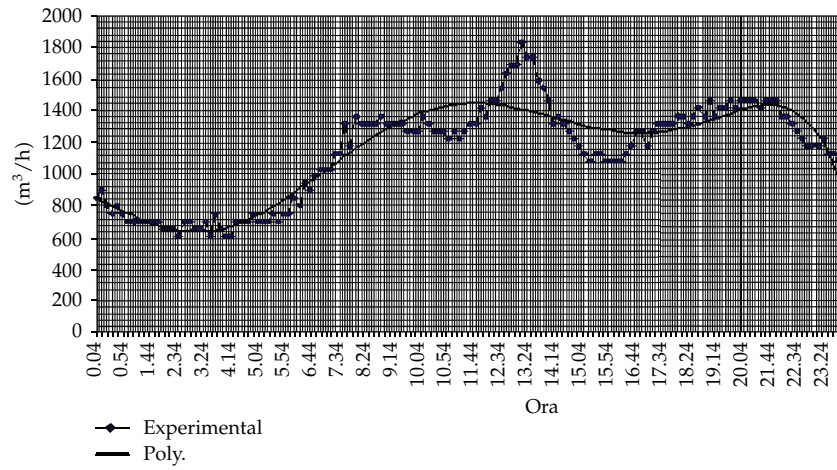

Figure 1: Variability of gas flow rate during a day in summer.

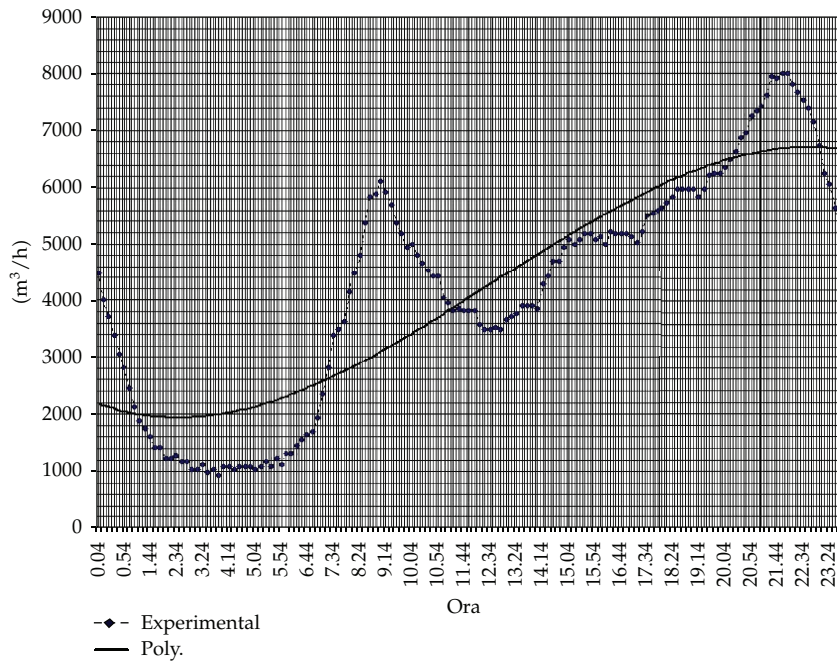

Figure 2: Variability of gas flow rate during a day in winter.

Moreover, in the case study input pressure of natural gas, far from being constant at an expected value of 24 bar, ranges from 22 to 25 bar, whereas input temperature varies between 5 and 30°C .

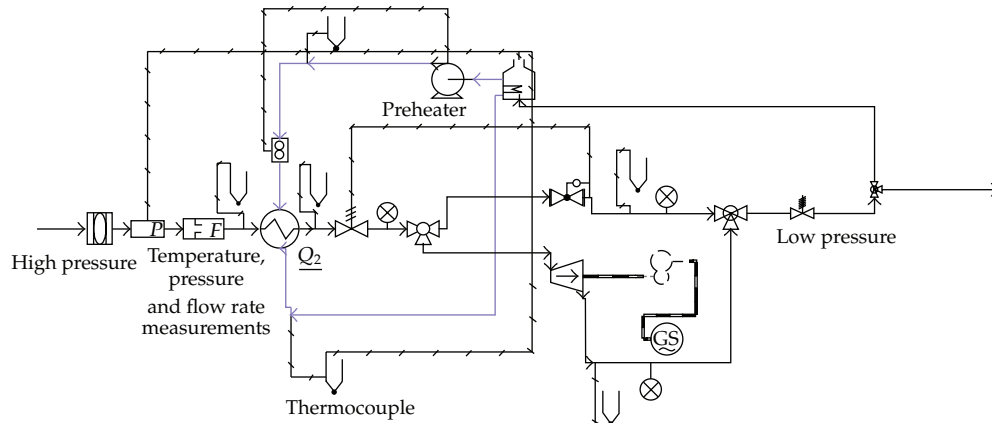

Figure 3: Flow diagram of the natural gas substation.

### 3. The Approach to the Optimal Design

In this paper an analysis of the city gas distribution net together with data of operative conditions of the substations is used to investigate the thermodynamic and economic feasibility of applying a turboexpander for energy recovery by designing and building-up a controlled gas substation. The control system had to ensure that both temperature and pressure of natural gas at the exit are constant whatever the pressures and temperatures at the inlet and whatever the gas flow rate. An intelligent connection between heaters and input values of gas temperature, pressure, and flow rates will save energy [16].

### 4. The Plant and the Alternatives

The original scheme of the expansion section of the plant before the intervention described in the present paper consisted only of a lamination valve. This is the most frequent arrangement as is the less expensive. However, no energy recovery is planned nor gas temperature or pressure control is installed. This, as above reported, may even lead to methane hydrates formation.

The first alternative examined in this paper is based on the use of a pre-heater section in the gas line. On the scale pan are put the pre-heater cost, the relevant operating costs, the money-saving deriving from the gas better quality due to the absence of methane hydrates.

Finally, the introduction of a turbine to recover energy during the gas expansion and of a fuzzy controller to manage the gas pre-heating before expansion certainly increases the fixed costs, especially when compared to the investments for the typical scale of the gas substations, but allows a significant saving in the plant operating costs, even leading to the sale of the recovered energy.

### 5. The Plant

The plant in its final arrangement is sketched in Figure 3. The pre-heater section of the plant includes an industrial boiler that burns natural gas from the station and provides hot water at a temperature based on the pressure drop caused by the gas lamination.

A control system has to be designed for the plant, as it is necessary to easily decide whether to increase or decrease the pre-heating temperature and of what amount, to have the maximum electricity production with a minimum output temperature of 5°C and a maximum output pressure of 5 bars. This will also guarantee the electrical energy production stability.

In conventional applications, operative variables depend on mathematical models related to gas combustion, heat transfer, and turbine fluid dynamics, that are all fairly complicated, especially in systems where a large number of parameters is either hidden or has to be accounted for. The ability to use simple linguistic variables rather than numerical variables in order to work more easily with systems too complex for mathematical modeling is the main objective of fuzzy logic-based controllers.

## 6. The Fuzzy System

It is a while that fuzzy logic is successfully used in the process industry. Whatever the reason, either its ability to model imprecise and subjective notions or the easiness of building up controllers that do not need mathematical modeling of the process, fuzzy logic is nowadays applied in virtually all sectors of industry and science in the western world.

The basis of a fuzzy logic controller is the representation of linguistic descriptions as membership functions indicating the degree to which a value belongs to the class labeled by linguistic description. In fuzzy logic control algorithms, degree of membership serves as inputs. The determination of appropriate degree of membership is the part of the design process. Once the membership functions are defined, the actual input values are transformed to degree of membership (varying from 0 to 1) of linguistic descriptors. This process is called fuzzification. The resulting fuzzified data is passed through an inference mechanism that contains the rules for the output. After the rules are applied, the combined effect of all rules will be evaluated according to a proper weightage for each rule. The weightage will be generally used to fine-tune the fuzzy controller and this process is defuzzification [17–19].

Examples of applications can be found in literature, ranging from aircraft engine control to locomotive wheel sleep control, steam turbine start-up, SEP (symbol error probability) of HS-MRC (hybrid selection/maximal-ratio combining power supplier controller), up to domestic or industrial scale microwave ovens. Fuzzy logic is even used to the fed-batch cultures of microorganisms and for the on-line control of feeding rate of substrate [20].

Gas turbines controlled via neurofuzzy systems have been used in biomass-based electric power plants and adaptive fuzzy logic controller developed for turbine generator systems [5].

In the fuzzy system designed for this plant, as input variables gas temperature, pressure, and flow rate will be considered, whereas the output variable will be the pre-heating water temperature  $T^*$  at the heat exchanger inlet, that will range from 75 to 95°C. The controlled parameters are the output temperature  $T$ , the gas flow rate  $Q$ , and the gas input pressure  $P$ .

As for any fuzzy control, the rules adopted are logical rather than mathematical. Seven labels have been used to define the conditions of the system. The state of a variable is described as follows:

- (i) NL : negative large,
- (ii) NM: negative medium,
- (iii) NS: negative small,

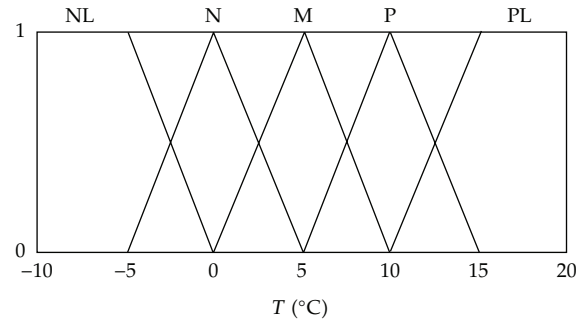

**Figure 4:** Membership functions of variable  $T$  ( $^{\circ}\text{C}$ ).

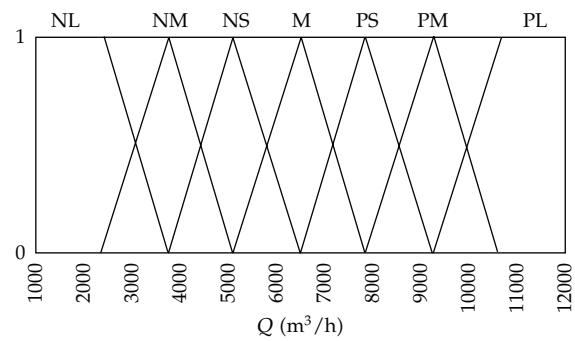

**Figure 5:** Membership functions of variable  $Q$  ( $\text{m}^3/\text{h}$ ).

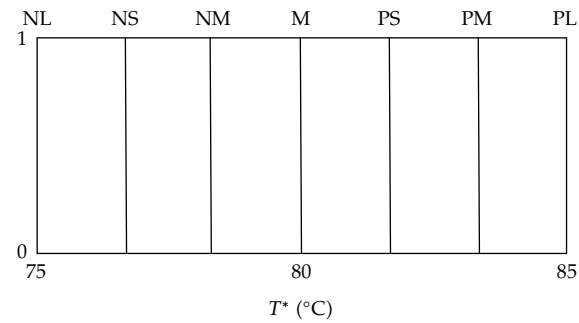

**Figure 6:** Membership functions of variable  $T^*$  ( $^{\circ}\text{C}$ ).

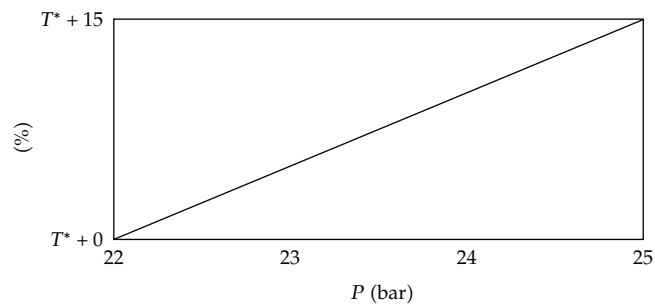

**Figure 7:** Correction of range of  $T^*$  as function of  $P$  (bar).

**Table 1:** FAM (Fuzzy Associative Memory) matrix.

<i>T</i>	<i>Q</i>						
	NL	NM	NS	M	PS	PM	PL
NL	PS	PS	PM	PM	PM	PL	PL
N	M	M	PS	PS	PS	PS	PM
M	NS	M	M	M	M	PS	PS
<i>P</i>	NM	NM	NM	NS	NS	M	M
PL	NL	NL	NM	NM	NS	NS	NS

- (iv) M : medium,
- (v) PS: positive small,
- (vi) PM: positive medium,
- (vii) PL: positive large.

A triangular membership function (MF) has been used for the input variables, having experienced that this simple shape is satisfyingly accurate. The membership function of the output variable is a singleton, that is, a series of unit pulses, since in this way the center of gravity can be easier calculated when defuzzifying [21, 22].

The input and output variation intervals are.

- (i)  $10^\circ < T < 20^\circ$  [°C];
- (ii)  $1000 < Q < 12000$  [m<sup>3</sup>/h];
- (iii)  $22 < P < 25$  [bar];
- (iv)  $75^\circ < T^* < 95^\circ$  [°C].

Seven membership functions are assigned to *Q* and *T*\*. Five functions are instead assigned to *T*. Functions overlap is necessary to let the system to have a fuzzy rather than a boolean behavior. Figures 4, 5, and 6 report the membership functions of *T*, *Q*, and *T*\*, respectively.

In Figure 7 is reported the correction of the range of variability of temperature as a function of inlet gas pressure *P*. As *P* changes, the temperature range, that is, the subject of the fuzzy membership functions, has to be modified to best accomplish the energy balance.

In this system, 7 MFs have been adopted for *Q* and 5 MFs for *T*. We could thus have 35 input combinations and 245 different rules, using 7 output functions. Actually, the number of necessary rules is quite smaller. In our case, an FAM (Fuzzy Associative Memory) matrix has been used. In the matrix, first line and first column report the input variables, whereas the output variable is derived according to the rule

$$T \text{ and } Q \longrightarrow T^* \quad (6.1)$$

The matrix is reported in the above table.

## 7. Results

As previously pointed out, the gas outlet temperature is the crucial variable and the one monitored as marker of the efficacy of the control system designed. It has to be outlined that

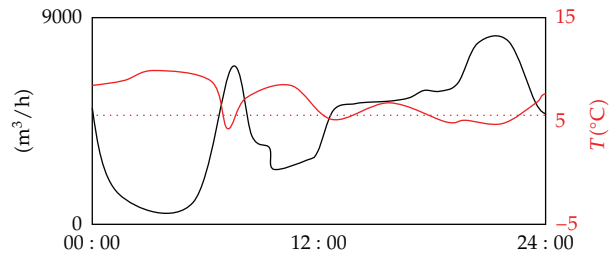

**Figure 8:** Variability of gas flow rate (black line) and temperature (red line) in a winter day.

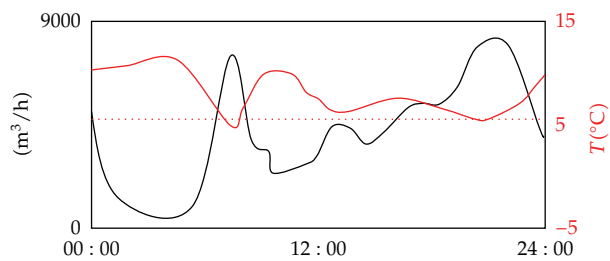

**Figure 9:** Variability of gas flow rate (black line) and temperature (red line) in a winter day with the pre-heating system.

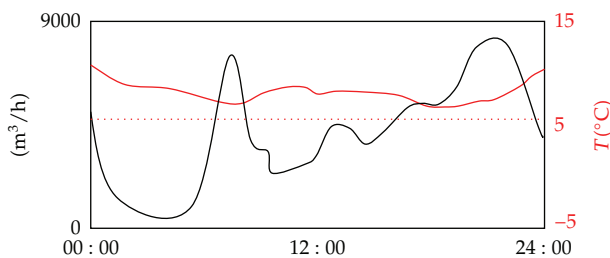

**Figure 10:** Variability of gas flow rate (black line) and temperature (red line) in a winter day with the pre-heating system and a fuzzy control.

each of the parameters considered concurs to complicate the whole picture: variability of the gas flow rate interferes with the plant energy balance as much as environmental conditions and adduction gas ducts temperature themselves.

Figure 8 shows that the outlet temperature continuously changes during a winter day when no control systems are applied to the plant. Figures 9 and 10 show the effect of introducing the pre-heating system and eventually the fuzzy control to manage the gas expansion.

It is remarkable the effect of the optimization performed in smoothing the outlet gas temperature, that tends to flatten on the 5°C value desired.

Note that the more the outlet temperature approaches 5°C from the above, the larger is the amount of energy saved, the better is the efficiency of the fuzzy control realized.



## 8. Conclusions

The radial flow turbine selected for this work can handle a large flow rate variability at variable inlet gas temperature at an affordable price. The investment costs of the fuzzy system are negligible, being basically related to the measurement equipments, whereas the energy recovery is larger than 15%. The fuzzy control system also helps in decreasing the maintenance costs of about 15% and allows to save up to 3 T.E.P. in a year, producing up to 450000 kWh. The payback of the investment cost is reached in less than 8 years, against an expected 25 years life-cycle. The turboexpander driven by fuzzy logic as above allows to recover and to sell to the National Electricity Board up to 450,000 kWh per year.

When considering that the size of the substation selected for this case study is considered representative of the Italian gas net, the existing network of gas distribution substations once fuzzy controlled becomes a network of electricity generators of 200 to 500 kW.

Combined use of fuzzy logic and neural networks would lead to autoadaptive intelligent systems, which actually appear to be the future.

## References

- [1] R. Shinnar and F. Citro, "A road map to U.S. decarbonization," *Science*, vol. 313, no. 5791, pp. 1243–1244, 2006.
- [2] A. J. Fawke, H. I. H. Saravanamuttoo, and M. Holmes, "Experimental verification of a digital computer simulation method for predicting gas turbine dynamic behaviour," *Proceedings of the Institution of Mechanical Engineers*, vol. 186, no. 27, pp. 323–329, 1972.
- [3] T. Schobeiri, "Digital computer simulation of the dynamic operating behaviour of gas turbines," *Brown Boveri Review*, vol. 74, no. 3, pp. 161–173, 1987.
- [4] M. Lown, E. Swidenbank, and B. W. Hogg, "Adaptive fuzzy logic control of a turbine generator system," *IEEE Transactions on Energy Conversion*, vol. 12, no. 4, pp. 394–399, 1997.
- [5] F. Jurado, M. Ortega, A. Cano, and J. Carpio, "Neuro-fuzzy controller for gas turbine in biomass-based electric power plant," *Electric Power Systems Research*, vol. 60, no. 3, pp. 123–135, 2002.
- [6] A. Hussain and H. Seifi, "Dynamic modeling of a single shaft gas turbine," in *Proceedings of the IFAC Symposium on Control of Power Plants and Power Systems*, IFAC Symposia Series, pp. 43–48, Pergamon Press, Munich, Germany, March 1992.
- [7] W. W. Hung, "Dynamic simulation of gas-turbine generating unit," *IEE Proceedings C: Generation Transmission and Distribution*, vol. 138, no. 4, pp. 342–350, 1991.
- [8] W. I. Rowen, "Simplified mathematical representations of heavy duty gas turbines," *Journal of Engineering for Power*, vol. 105, no. 4, pp. 865–869, 1983.
- [9] A. Cleveland, "Power Generation with Turbo Expanders," ASME 90-DT-2, 1992.
- [10] R.A.C.I. s.r.l., Settore Progettazione, "Schede Tecniche-Prestazioni Termodinamiche di impianti di turboespansione," ST 1042200, 2002.
- [11] H. E. RohliK, "Analytical determination of radial inflow turbine geometry for maximum efficiency," Tech. Rep. TN D-4384, NASA, 1968.
- [12] S. K. Ghosh, "Computation of velocity, pressure and temperature profiles in a cryogenic turboexpander," in *Proceedings of the 18th National & 7th ISHMT-ASME Heat and Mass Transfer Conference*, IIT Guwahati, January 2006.
- [13] "Application of turboexpanders for pressure letdown energy recovery in the natural gas industry," American Gas Association, 1987.
- [14] M. P. Boyce, *Gas Turbine Engineering Handbook*, Gulf Professional, Butterworth, Malaysia, 2nd edition, 2002.
- [15] L. C. Kun, "Expansion turbine and refrigeration for gas separation and liquefaction," *Advances in Cryogenic Engineering*, vol. 33, pp. 963–973, 1988.
- [16] O. E. Balje, *Turbomachines—A Guide to Design, Selection and Theory*, John Wiley & Sons, New York, NY, USA, 1981.
- [17] B. Kosko, *Il Fuzzy Pensiero. Teoria e Applicazioni della Logica Fuzzy*, Baldini e Castoldi Milano, 2002.

- [18] S. Cammarata, *Sistemi a logica fuzzy—come rendere intelligenti le macchine*, Etas Libri, 2nd edition, 1997.
- [19] H. J. Zimmermann, *Fuzzy Set Theory and Its Applications*, Kluwer Academic Publishers, Boston, Mass, USA, 2009.
- [20] P. P. Bonissone, V. Badami, K. H. Chiang, P. S. Khedkar, K. W. Marcelle, and M. J. Schutten, "Industrial applications of fuzzy logic at general electric," *Proceedings of the IEEE*, vol. 83, no. 3, pp. 450–465, 1995.
- [21] M. Pappalardo, A. Pellegrino, M. d'Amore, and F. Villecco, "Design of a fuzzy control for a microwave monomode cavity to soot trap filter regeneration," in *Intelligence in a Small World—Nanomaterials for the 21st Century*, CRC- Press, Boca Raton, Fla, USA, 2003.
- [22] M. Pappalardo, A. Pellegrino, R. Carmando, F. Villecco, R. Ametrano, and M. d'Amore, "A fuzzy controller for the indoor atmosphere of a pharmaceutical plant," in *Proceedings of the 5th International Conference on Intelligent Processing and Manufacturing of Materials*, July 2005.